



SERIES 16

RAISING THE BAR
MP - COUNT ON IT

Thermal Circuit Breaker
Superior Current Interrupt Capabilities
0.5 Amp to 70 Amp
UL 1077
Ignition Protected
Cadmium Free



SUPERIOR CIRCUIT PROTECTION

www.mechprod.com

Series 16 Overview

FEATURES:

AC/DC ratings from 0.5 to 70 Amps
 UL1500 Ignition Protection
 UL, cUL, CSA, VDE, CCC
 RoHS Compliant
 Choice of snap-in or thread mounting
 Multiple hardware and boot options
 Variety of termination options



Snap-in bushing

7/16" Boot - Clear
 1600-382-1

Series 16 Specifications

Standard Amp Ratings	0.5, 0.75, 1.0, 1.5, 2.0, 2.5, 3.0, 3.5, 4.0, 4.5, 5.0, 6.0, 7.0, 7.5, 8.0, 9.0, 10, 12, 14, 15, 18, 20, 25, 30, 35, 40, 45, 50, 55, 60, and 70 Amps
Maximum Voltage Ratings	1601/1681: 250VAC thru 4.5A, 50VDC thru 4.5A 1600/1680: 250 VAC thru 35A, 50VDC thru 35A 1648: 125VAC thru 70A, 250VAC thru 50A, 32VDC thru 55A, 50VDC thru 40A
Minimum Ultimate Trip	100% of rated current at 25°C / 77°F
Maximum Ultimate Trip	Below 1A – 145% Between 1A and 35A inclusive – 135% At 40A and above – 140% - Of rated current at 25°C / 77°F
Dielectric Strength	Exceeds 1,500V per UL, CSA, and VDE
Interrupt / Voltage Ratings	1,000A @ 50VDC – up to 35A 3,000A @ 32VDC – 5 to 70A* 2,000A @ 125VAC – 5 to 35A 1,000A @ 125VAC – 40A and above <i>*MP Certified</i>
Overload Capacity	10X rated current for 5.0A – 35A 6X rated current for 0.5A – 4.5A
Ignition Proof	Ratings of 0.5 – 70A conform to USCG Title 33, DFR, Section 183.410(a) per UL1500 Standard for Safety for Ignition-Protection Test for Marine Products
Motor load rated	Models 1600, 1601, 1680, 1681
Corrosion	96hrs salt spray per MIL-STD-202, Method 101, Test Condition A
Humidity	240hrs at 95% RH per MIL-STD-202, Method 103, Test Condition A
Shock	30g
Vibration	8g
Regulatory Compliance Summary	UL/cUL recognition per UL 1077 (E66224), CSA per C22.2 No. 235-04 (LR27156), VDE per DIN EN 60934 (VDE0642) (40003670 & 40003682), and CCC. All are RoHS Compliant.

Suitable for diverse applications such as:
 Uninterruptible Power Systems (UPS), Industrial Cleaning Equipment,
 Portable Generators, Medical Equipment, Transportation, Welders,
 Marine, & RV

Overload Trip Time Data (in seconds)

Current Rating	200%	300%	400%	500%	600%	800%	1000%
0.5 - 4.5 A	10 - 32	5 - 12	3.5 - 6.3	3.0 - 4.7	2.3 - 4.2	-	-
5.0 - 7.5 A	4 - 15	1.4 - 5.2	.75 - 3.0	0.5 - 1.8	0.35 - 1.25	0.2 - 0.8	0.16 - 0.66
8 - 70A	5 - 30	1.5 - 7.5	0.8 - 4.5	0.5 - 2.8	0.4 - 1.9	0.2 - 1.1	0.15 - 0.78

Ambient Temperature Correction Factor

Current Rating	°F	77	104	122	140
	°C	25	40	50	60
0.5 - 4.5A		1.00	1.16	1.33	1.61
5 - 7.5A		1.00	1.32	1.87	Call for info
8 - 35A		1.00	1.15	1.31	1.55
40 - 70A		1.00	1.11	1.21	1.34

Voltage Drop

Ampere Range	Voltage Drop
0.50-0.75	3V
1.0 - 4.5	1V
5.0 - 9.0	0.25V
12.0 - 14.0	0.20V
15.0 - 35.0	0.15V
40.0 - 45.0	0.10V
60.0 - 70.0	0.06V

Series 16 Operating Characteristics

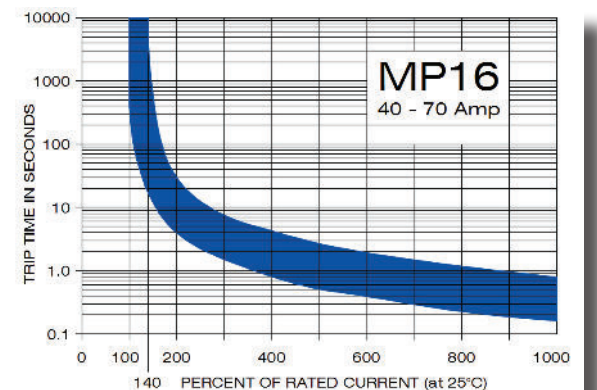
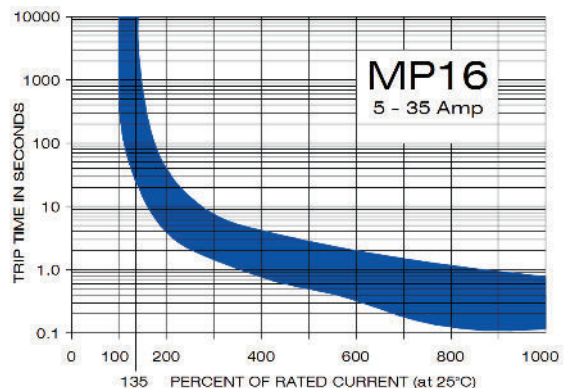
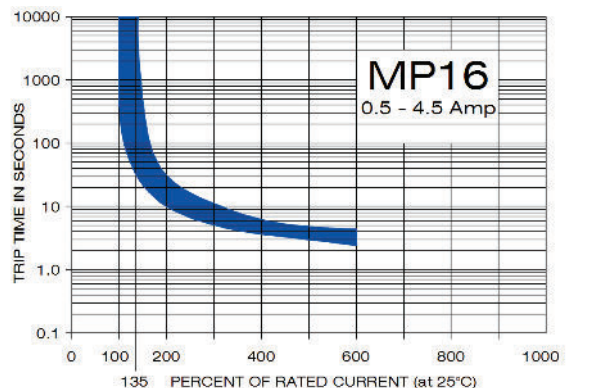

Trip curves presented here are based on typical samples and are for reference. Please consult the factory for more specific application information

Trip curves are specified at 25°C / 77°F



Series 16 Physical Configuration

Case Sizes

(See Part Numbering Guide)

All dimensions in inches, (mm)

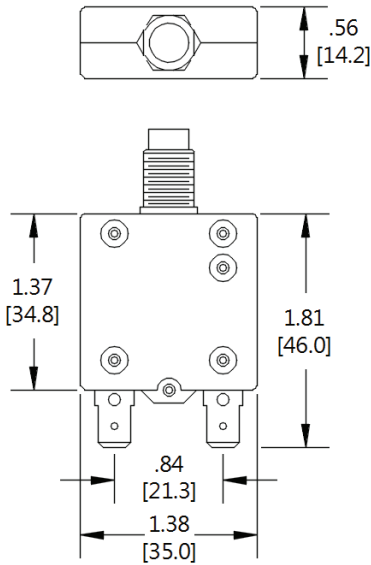

LOW AMP

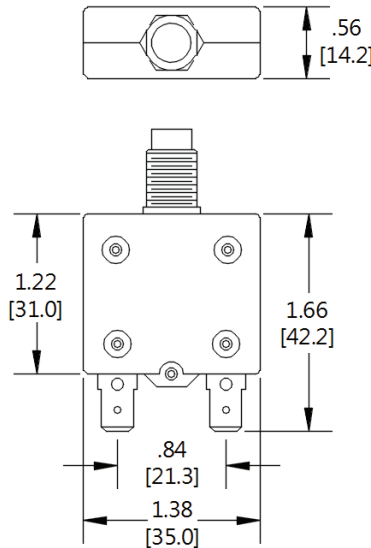

MID AMP

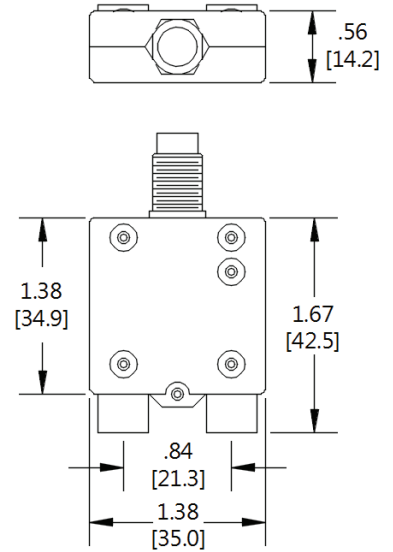

HIGH AMP

Bushing Options

(See Part Numbering Guide)

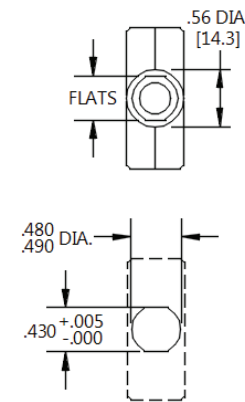
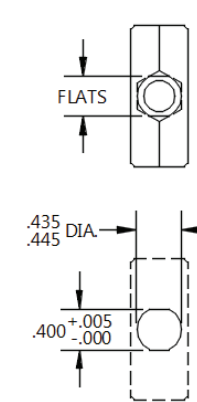
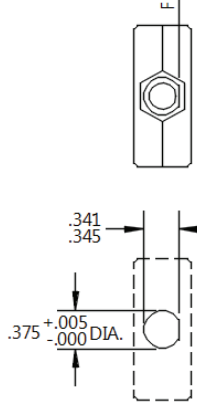
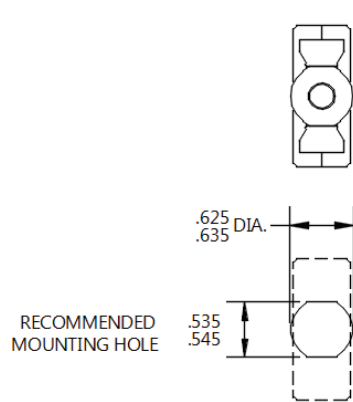
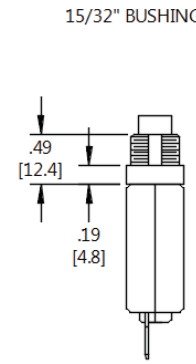
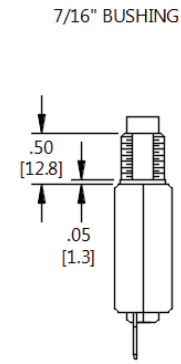
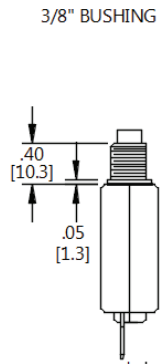
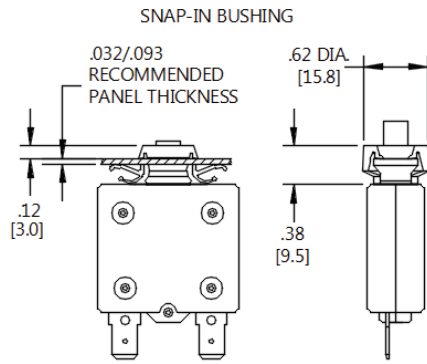

Terminal Options

(See Part Numbering Guide)

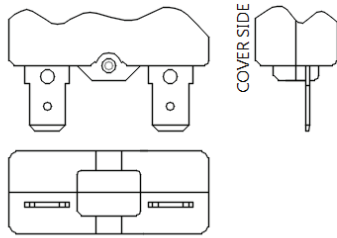

.250x.032 QC, straight

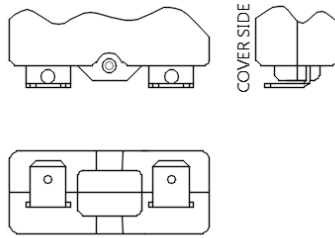

QC, bent

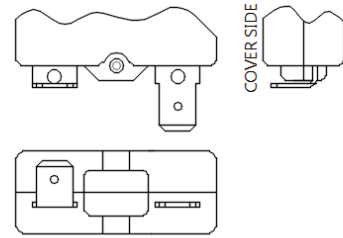

QC, bent & QC straight

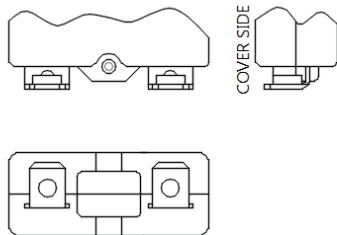

#6-32 or #8-32 threaded, bent

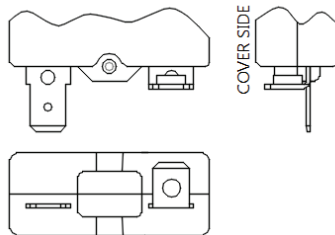

.250x.32 QC straight,
#6-32 or #8-32, bent

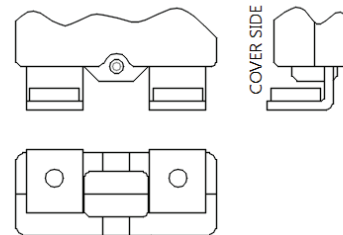

#10-32 threaded, bent
(1648 only)

- For VDE approved screw terminal devices, the use of ring or "U" shaped wire connectors is required

Hardware Options

(See Part Numbering Guide)



To visit the MP website:



Series 16 Part Numbering Guide

Low Amp 0.5 to 4.5A



XX = Unspecified

1601 Model Variation Codes			
Model Code	Bushing Mounting	Button / Amp Stamp Color	Terminal Type
1601-001	7/16"-28 Diecast	White / None	0.250" quick connect
1601-015		White / Black	
1601-065		White / Red	#6-32 threaded, bent 90
1601-073			
1601-067	Snap-In Black	White / None	0.250" quick connect
1601-251 ¹			

Amp Rating	
Code	Amps
050	0.5
075	.75
100	1.0
150	1.5
200	2.0
250	2.5
300	3.0
350	3.5
400	4.0
450	4.5

7/16" - 28 Hardware	
Code	Hardware Configurations
00	No Hardware
06	Hexnut
07	Knurknet/Palnut/Nameplate
11	Knurlnut (aluminum)
15	Knurlnut/Palnut
18	Hexnut/Hexnut/Nameplate
23	Hexnut/Hexnut
32	Knurlnut/Hexnut/Lockwasher
A0	Knurlnut/Hexnut (2) #6 terminal screws & washers
A1	Knurlnut/Hexnut/Nameplate (2) #6 terminal screws & washers
B4	Protective Rubber Boot (clear)/ Palnut

1681 Model Variation Codes			
Model Code	Bushing Mounting	Button / Amp Stamp Color	Terminal Type
1681-001	3/8"-27 Nylon	White / None	0.250" quick connect
1681-015		White / Black	#6-32 threaded, bent 90
1681-254 ¹		White / None	0.250" quick connect

3/8"-27 Hardware	
Code	Hardware Configurations
00	No Hardware
44	Hexnut
50	Knurlnut/Palnut/Nameplate
51	Knurlnut/Palnut
54	Hexnut/Hexnut
75	Hexnut/Hexnut/Nameplate
79	Knurlnut (aluminum)
97	Knurlnut (black nylon) /Lockwasher
A4	Knurlnut/Hexnut (2) #6 terminal screws & Washers
A5	Knurlnut/Hexnut/Nameplate (2) #6 Terminal Screws & Washers
D3	Knurlnut (black nylon)
F4	(2) Knurlnuts / Lockwasher

All models are UL, CSA, & CCC, ¹includes IEC



1601-015-020-50

Series 16 Part Numbering Guide

Mid Amp 5 to 35A

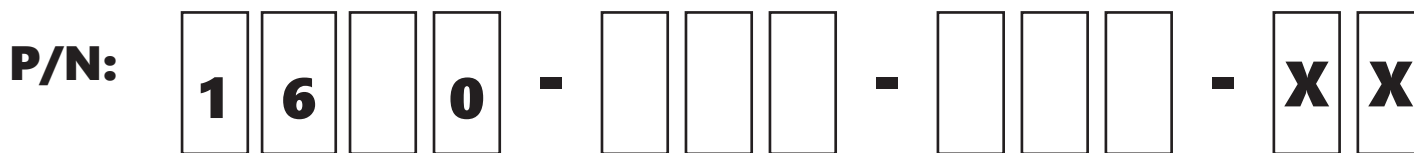

XX = Unspecified

1600 Model Variation Codes			
Model Code	Bushing Mounting	Button / Amp Stamp Color	Terminal Type
1600-001	7/16"-28 Diecast	White / None	0.250" quick connect
1600-037		White / Black	
1600-055		White / None	#6-32 threaded bent 90
1600-082		White / Black	
1600-180		White / None	0.250" quick connect bent 90
1600-235			(1) #8-32" threated bent 90* (1) 0.250" quick connect
1600-007	15/32"-32 Diecast	White / None	0.250" quick connect
1600-107		White / Black	
1600-111			#6-32 threaded bent 90
1600-144	Snap-In Black	White / None	0.250" quick connect
1600-175			#8-32 threaded bent 90
1600-254 ¹		White / Black	0.250" quick connect
1600-255 ¹			0.250" quick connect bent 90 away from case
1600-263 ¹		White / None	

Amp Rating	
Code	Amps
050	5.0
060	6.0
070	7.0
075	7.5
080	8.0
090	9.0
100	10.0
120	12.0
140	14.0
150	15.0
180	18.0
200	20.0
250	25.0
300	30.0
350	35.0

7/16" - 28 Hardware	
Code	Hardware Configurations
00	No Hardware
06	Hexnut
07	Knurknet/Palnut/Nameplate
11	Knurlnut (aluminum)
15	Knurlnut/Palnut
18	Hexnut/Hexnut/Nameplate
23	Hexnut/Hexnut
32	Knurlnut/Hexnut/Lockwasher
A1	Knurlnut/Hexnut/Nameplate (2) #6 terminal screws & washers
A2	Knurlnut/Palnut (2) #6 terminal screws & washers
B4	Protective Rubber Boot (clear)/ Palnut

1680 Model Variation Codes			
Model Code	Bushing Mounting	Button / Amp Stamp Color	Terminal Type
1680-001	3/8"-27 Nylon	White / None	0.250" quick connect
1680-037		White / Black	
1680-055		White / None	#6-32 threaded bent 90
1680-082		White / Black	
1680-217		Black / None**	0.250" quick connect
1680-219			#8-32 threaded bent 90
1680-228		Black / None	0.250" quick connect
1680-252 ¹		White / None	
1680-253 ¹		White / Black	
1680-271 ¹			

3/8"-27 Hardware	
Code	Hardware Configurations
00	No Hardware
44	Hexnut
50	Knurlnut/Palnut/Nameplate
51	Knurlnut/Palnut
54	Hexnut/Hexnut
75	Hexnut/Hexnut/Nameplate
79	Knurlnut (aluminum)
97	Knurlnut (black nylon) /Lockwasher
A5	Knurlnut/Hexnut/Nameplate (2) #6 Terminal Screws & Washers
A9	Knurlnut/Lockwasher (2) #8 terminal screws & washers
B8	Knurlnut (black nylon)/Lockwasher (2) #8 terminals & washers
D3	Knurlnut (black nylon)
E2	Knurlnut/Palnut (2) #6 terminal screws & washers
F4	(2) Knurlnuts/Lockwashers

All models are UL, CSA, & CCC, ¹includes IEC



1112 N. Garfield St. Lombard, IL 60148 helpme@mechprod.com
phone 630 | 953 | 4100 fax 630 | 953 | 4110 www.mechprod.com

*Terminal Hardware Included
**With white trip indicator



WARNING: Cancer & Reproductive Harm
www.p65warnings.ca.gov/

Specifications subject to change

QC-4006-D

Series 16 Part Numbering Guide

High Amp 40 to 70A



XX = Unspecified

1648 Model Variation Codes			
Model Code	Bushing Mounting	Button / Amp Stamp Color	Terminal Type
1648-025	3/8"-27 Metal	White / Black	#10-32 threaded, bent 90°
1648-006	7/16"-28 Diecast	White / None	
1648-009		White / Black	
1648-001	15/32"-32 Diecast		
1648-017	Snap-In Black	White / None	

Amp Rating	
Code	Amps
040	40.0
050	50.0
055	55.0
060	60.0
070	70.0

7/16" - 28 Hardware	
Code	Hardware Configurations
00	No Hardware
06	Hexnut
07	Knurknet/Palnut/Nameplate
11	Knurlnut (aluminum)
15	Knurlnut/Palnut
18	Hexnut/Hexnut/Nameplate
23	Hexnut/Hexnut
32	Knurlnut/Hexnut/Lockwasher
B4	Protective Rubber Boot (clear)/ Palnut



1600-037-020-07
*See previous page



1648-009-060-07

3/8"-27 Hardware	
Code	Hardware Configurations
00	No Hardware
44	Hexnut
50	Knurlnut/Palnut/Nameplate
51	Knurlnut/Palnut
54	Hexnut/Hexnut
75	Hexnut/Hexnut/Nameplate
79	Knurlnut (aluminum)
97	Knurlnut (black nylon) /Lock-washer
D3	Knurlnut (black nylon)
F4	(2) Knurlnuts / Lockwasher